



# CLASSIC

10697



**WARNING: CHOKING HAZARD.**  
Toy contains small parts and a small ball.  
Not for children under 3 years.



[LEGO.com/classic](https://www.lego.com/classic)







## AVERTISSEMENT : RISQUE D'ÉTOUFFEMENT.

Le jouet contient des petites pièces ainsi qu'une petite boule.  
Il ne convient pas aux enfants de moins de 3 ans.



## ADVERTENCIA: PELIGRO DE ASFIXIA.

Juguete que contiene partes pequeñas y una pelota pequeña.  
No recomendado para niños menores de 3 años.



[LEGO.com/brickseparator](https://LEGO.com/brickseparator)





Easy Building  
Construction facile  
Construcción fácil



Medium Building  
Construction intermédiaire  
Construcción intermedia



Advanced Building  
Construction avancée  
Construcción avanzada



LEGO.com/  
classic

Page/pag.

58



Page/pag.

6





Page/pag.  
**25**

Page/pag.  
**64**



Page/pag.  
**34**





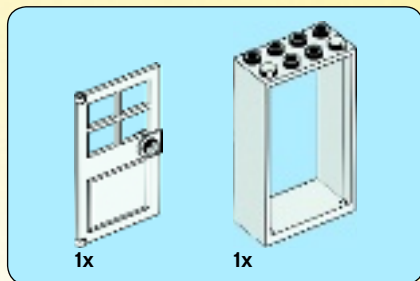

1

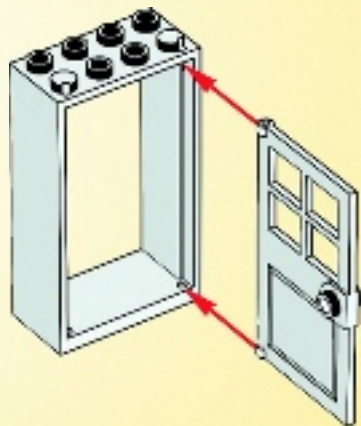

2



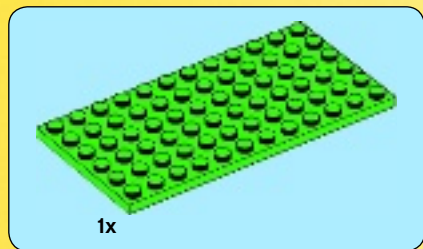

3

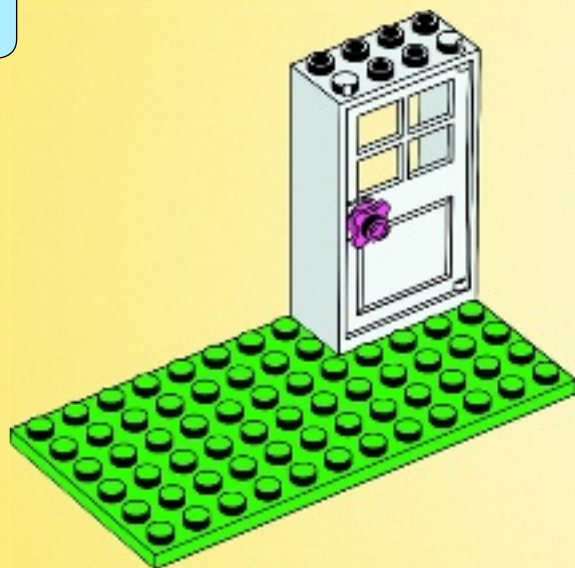





1x



1x

4

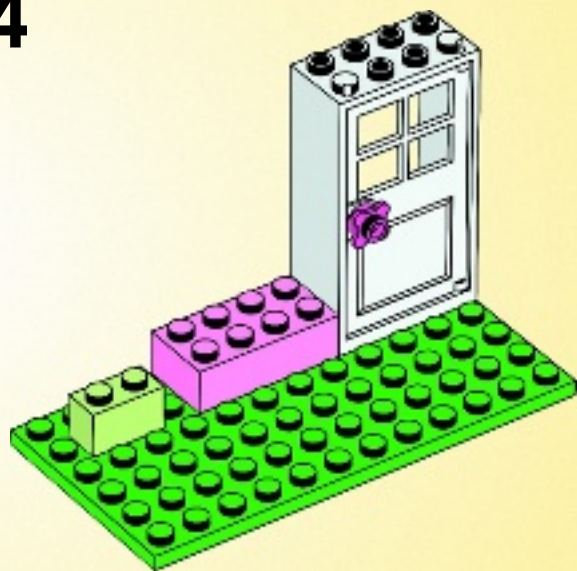

1x

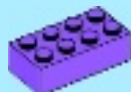

1x

5

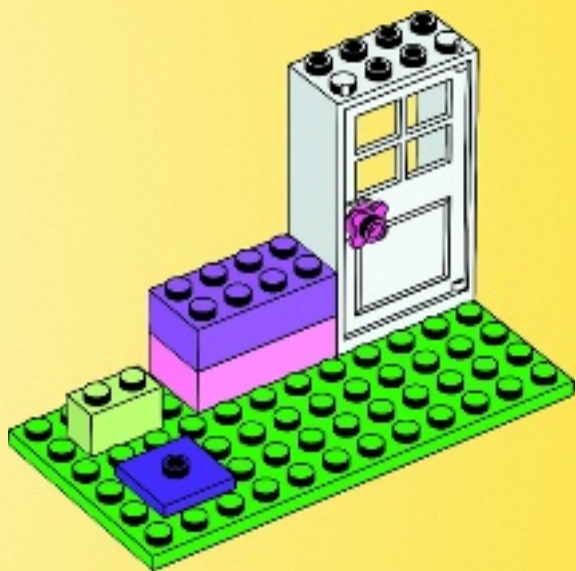

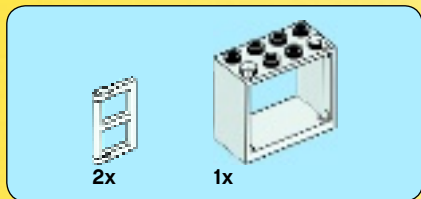

6

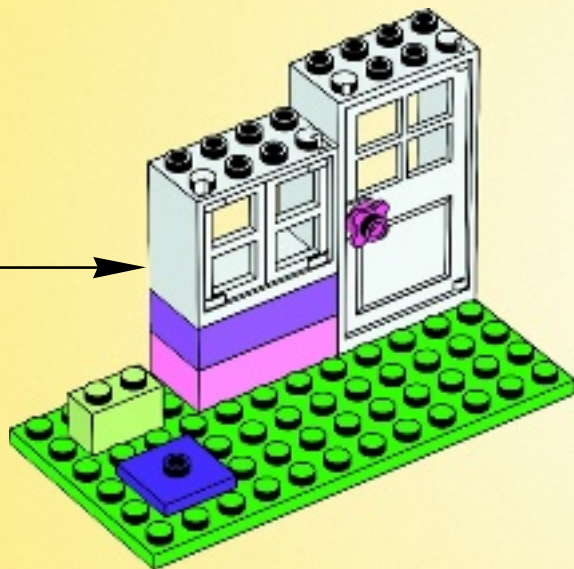
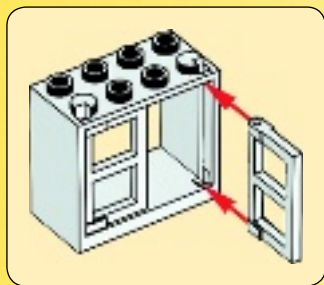



7





2x



2x

8



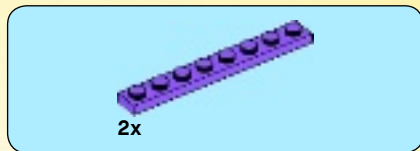

9





1x



1x

10

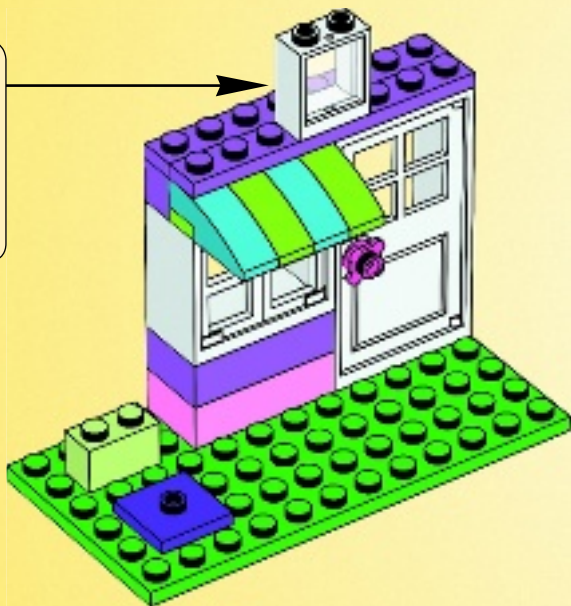
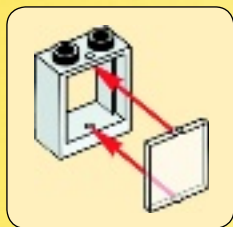



2x

11

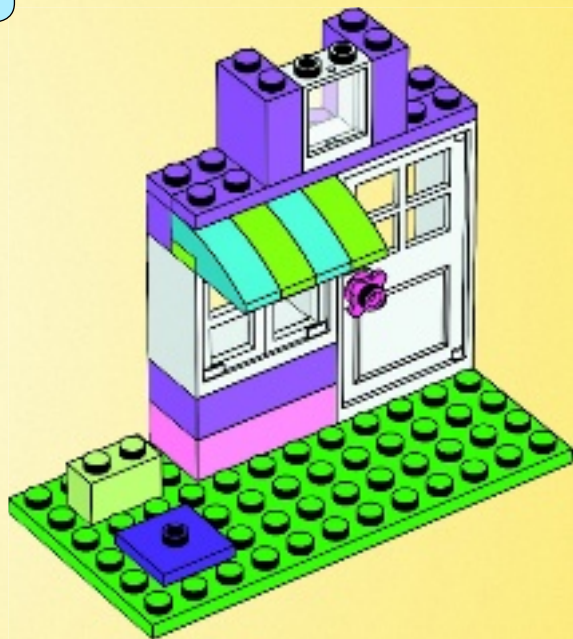



2x

12

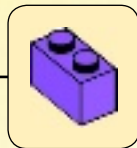
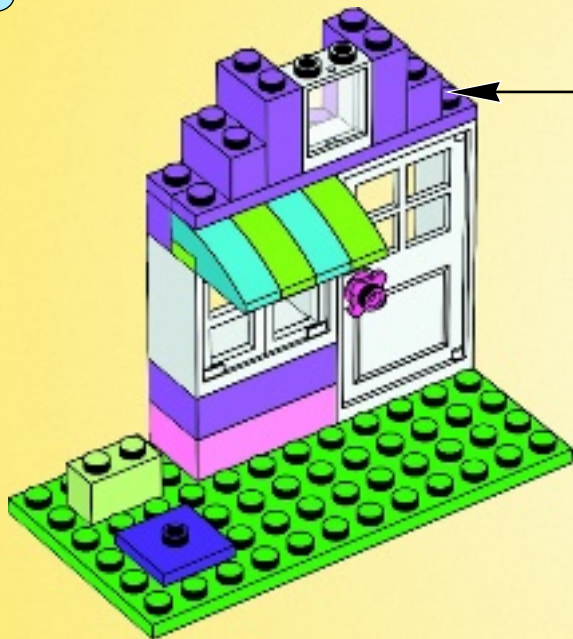





2x

13

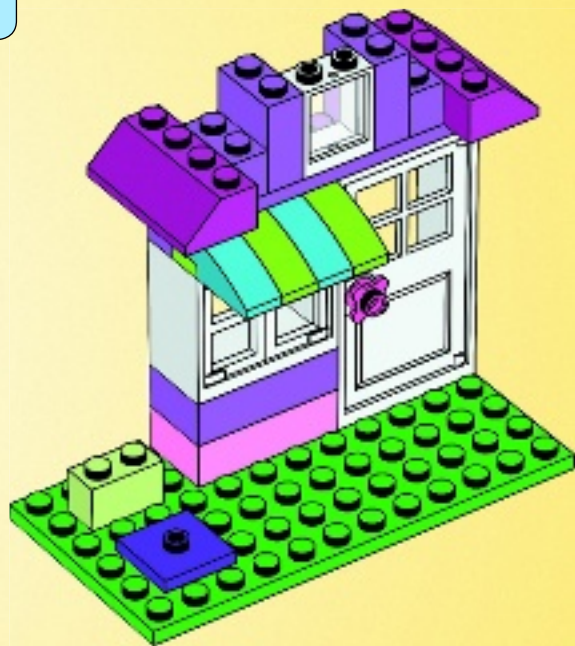



2x

14





2x



1x

15





2x

16





1x



1x

# 17

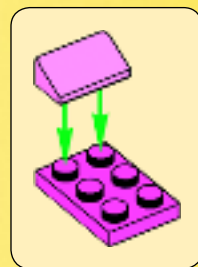



1x



1x



1x

# 18

1



2

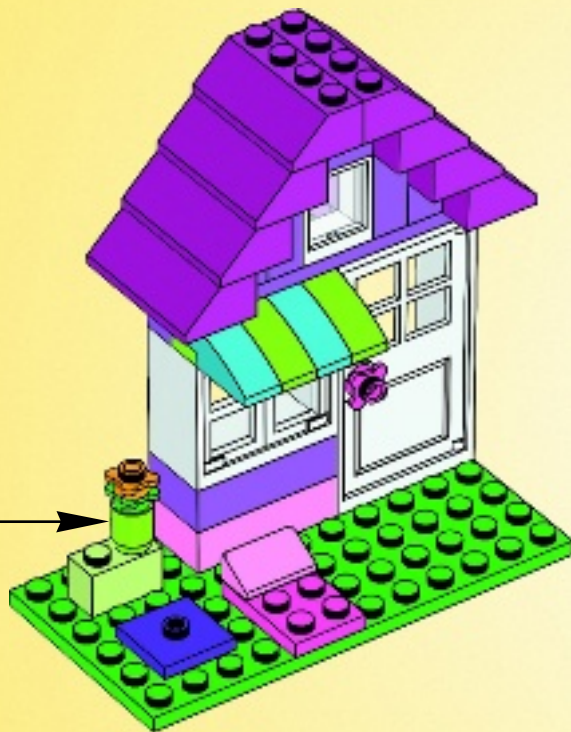



1x



1x

# 19



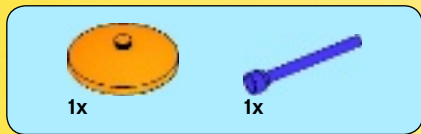

20

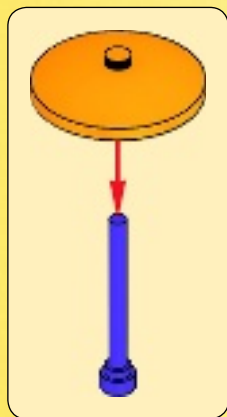



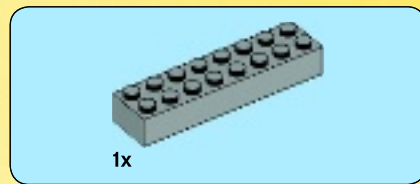

1

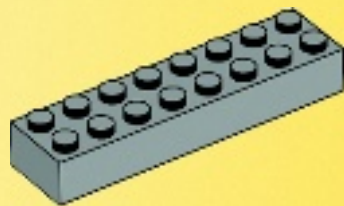



1x



1x

2

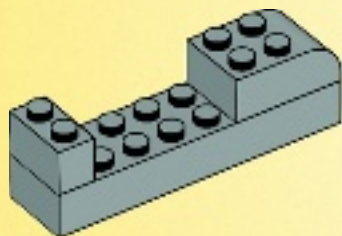



1x



2x

3

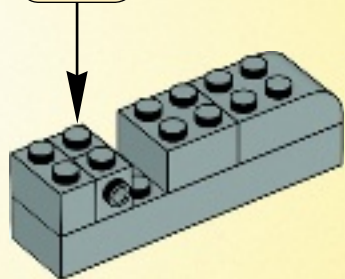

2x

4

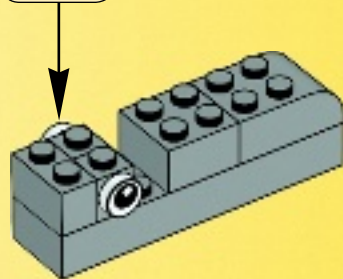

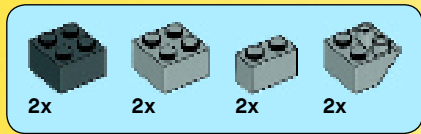

5

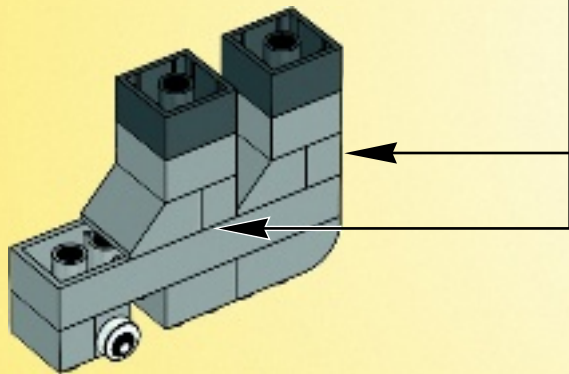
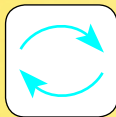
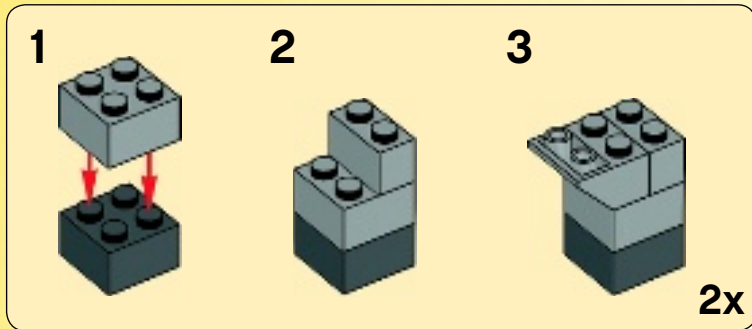



1x

6

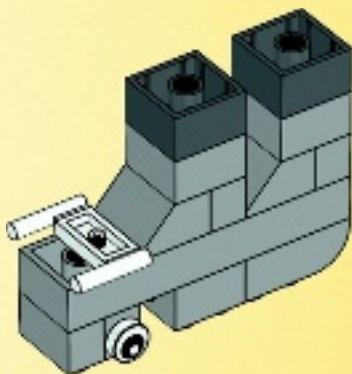



1x



2x

# 7

1

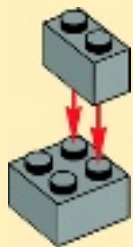

2

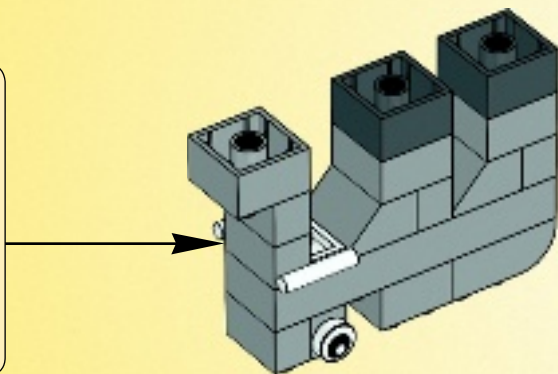
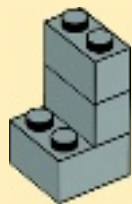



1x

8

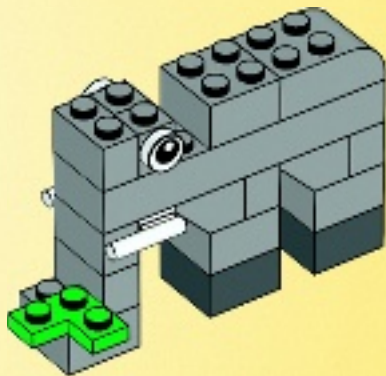
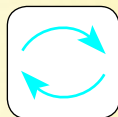

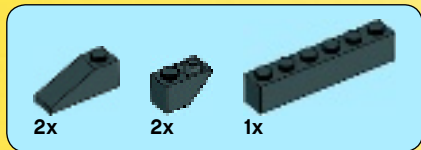

9

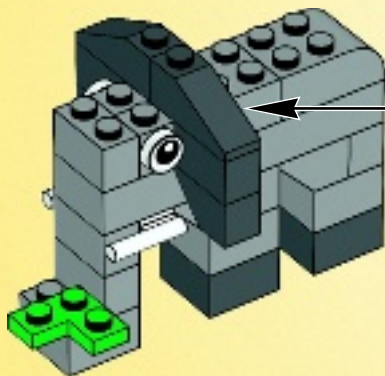
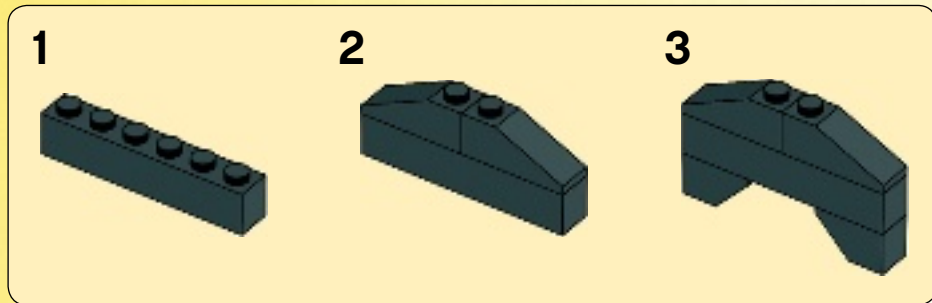





2x

10

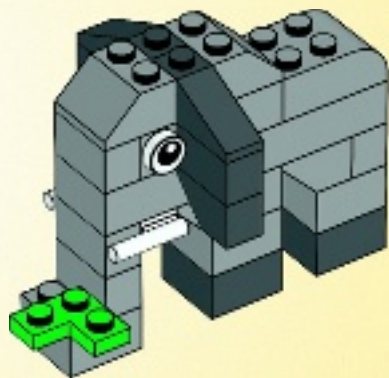

1x

11

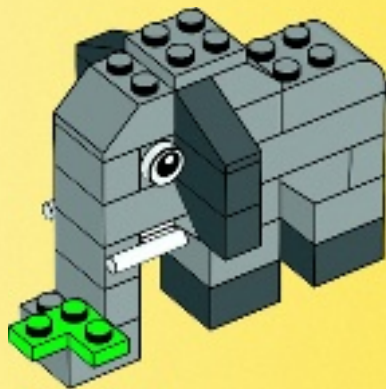



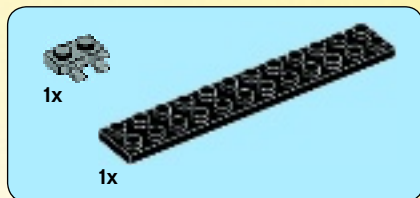

1

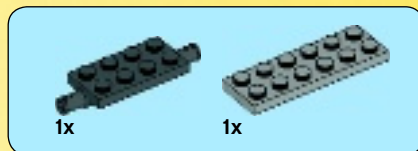
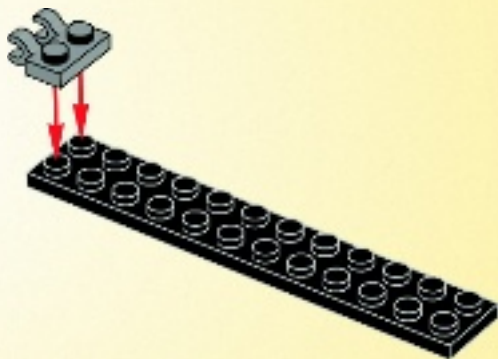

2





3

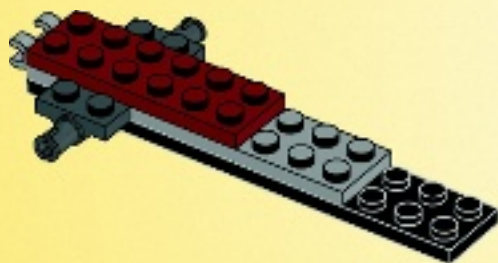



1x



1x

4

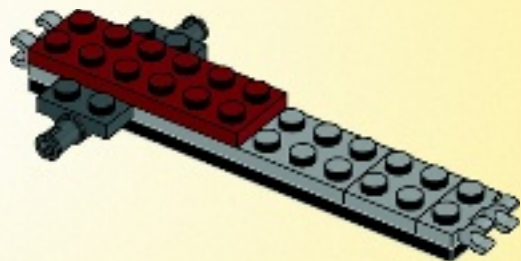

2x



1x

5

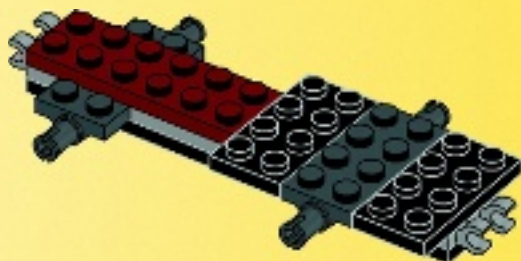

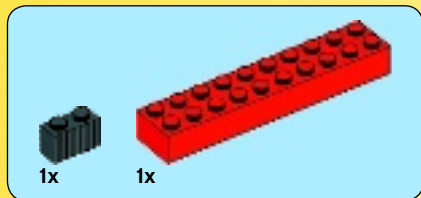

6

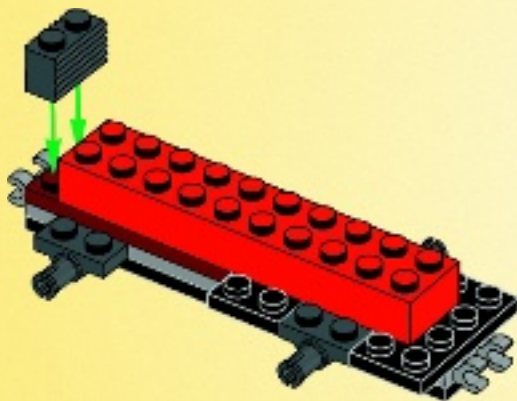



7

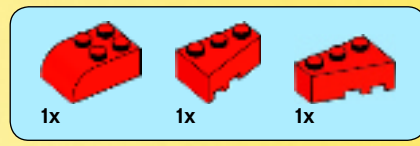
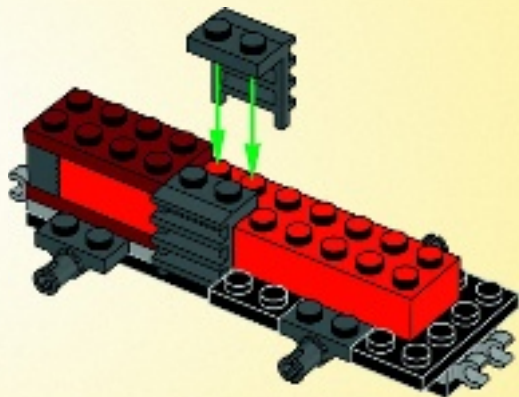

8

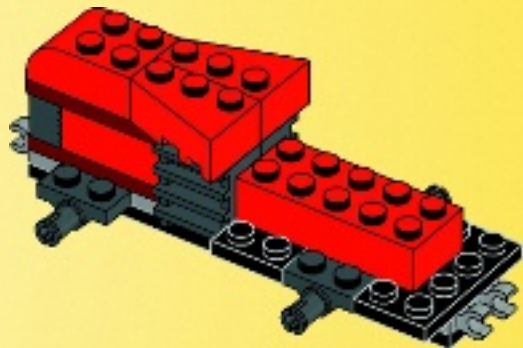



2x

9

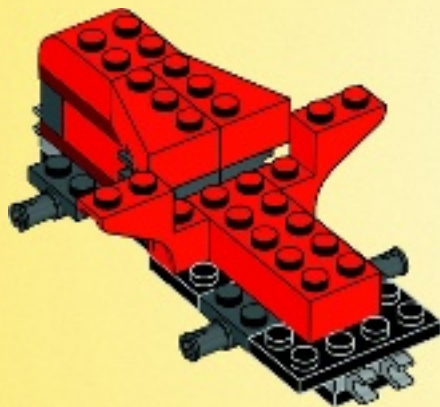





2x

# 10

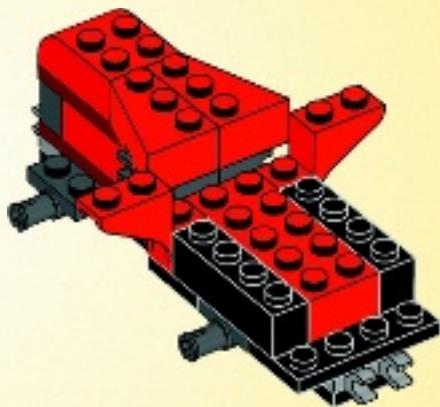

1x



2x

# 11

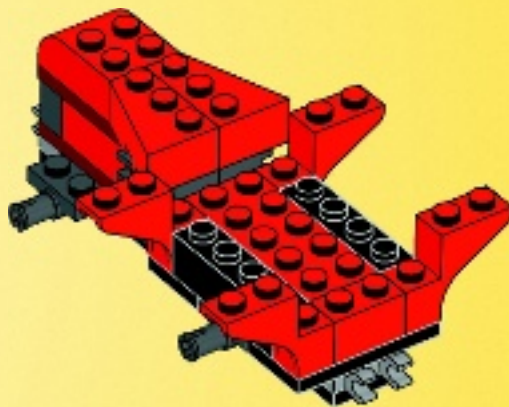



3x

12



3x

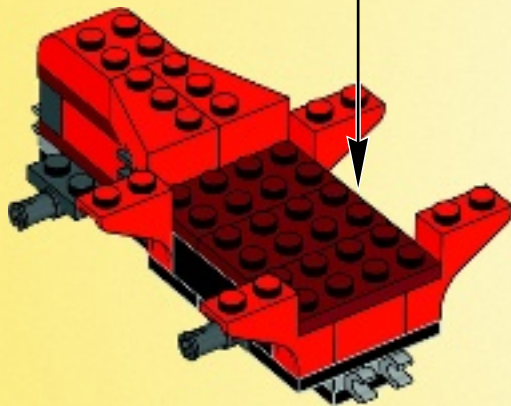

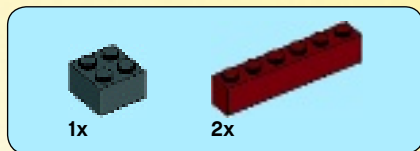

13

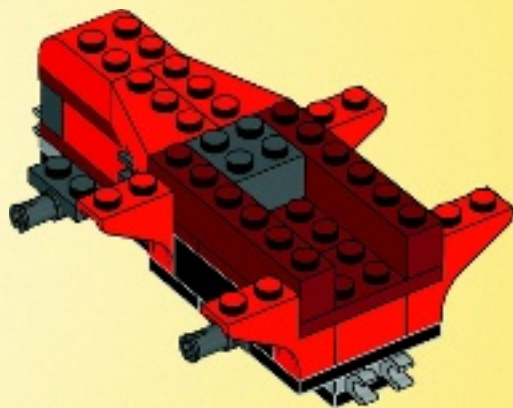

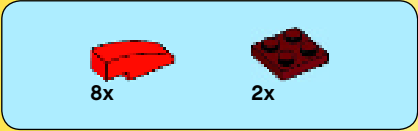

14

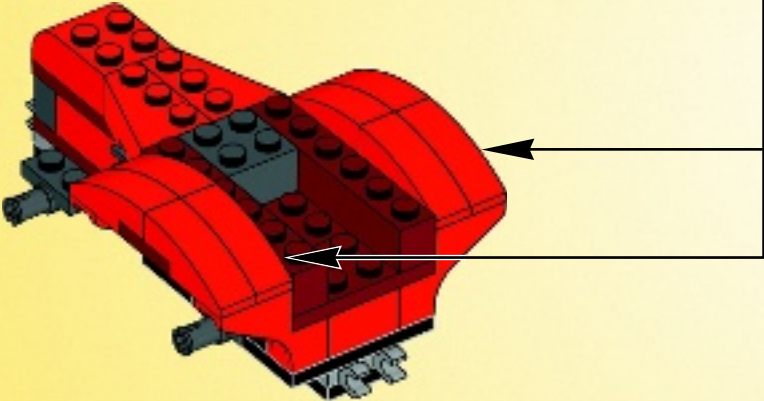
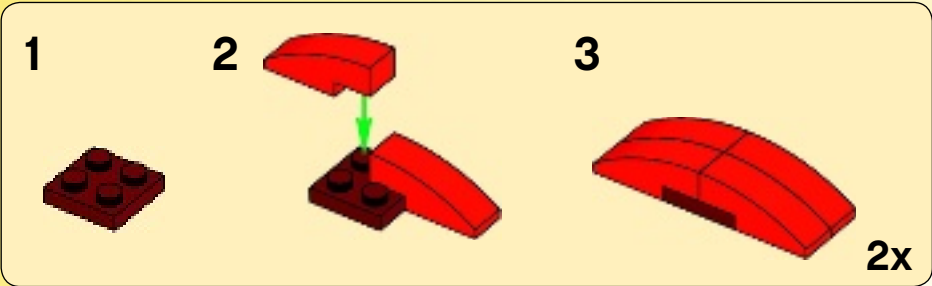



2x



2x



2x

# 15

1



2



1



2

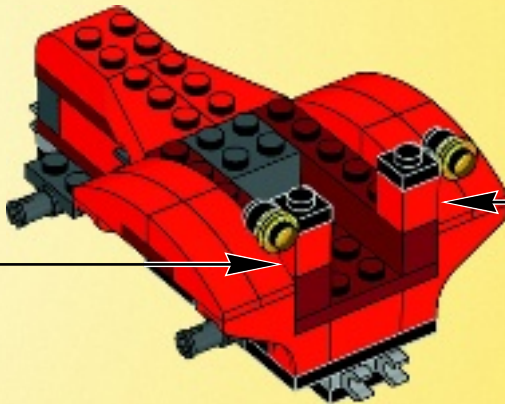



1x



1x

# 16

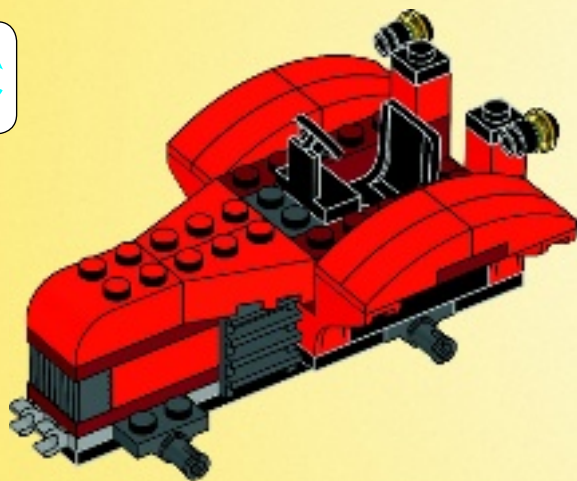
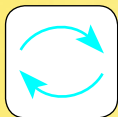

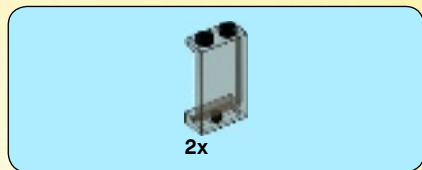

17

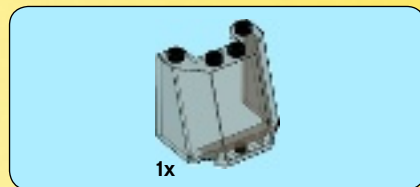
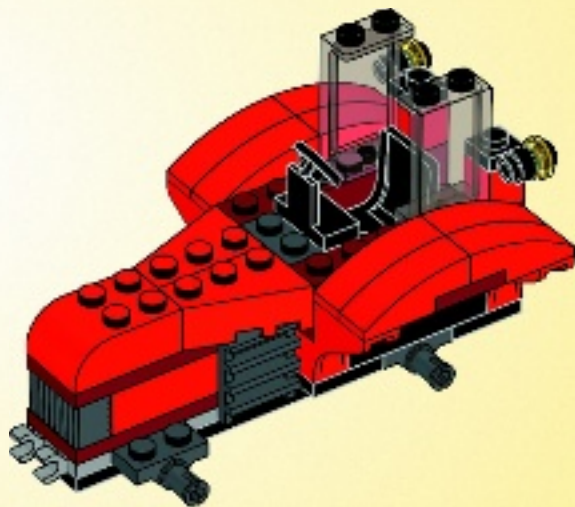

18

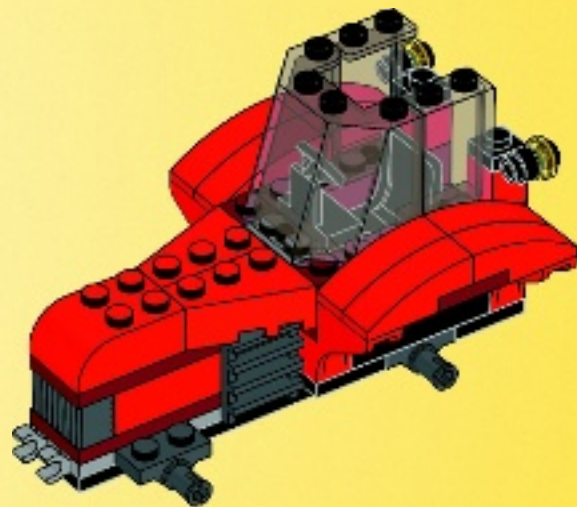



1x



1x

# 19

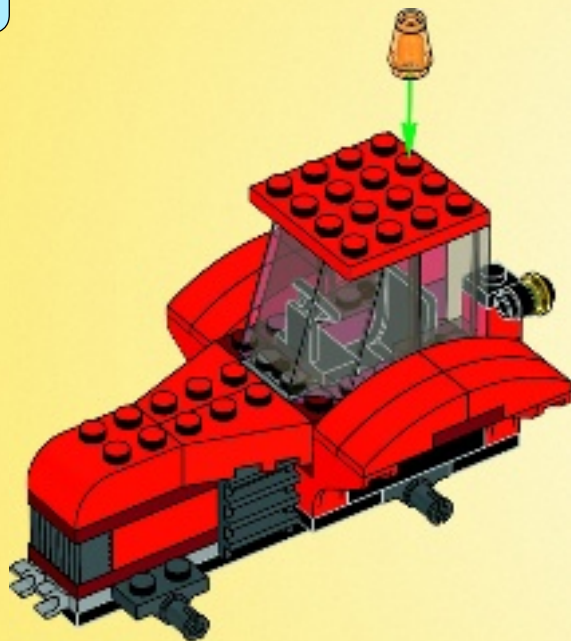





1x



1x

# 20

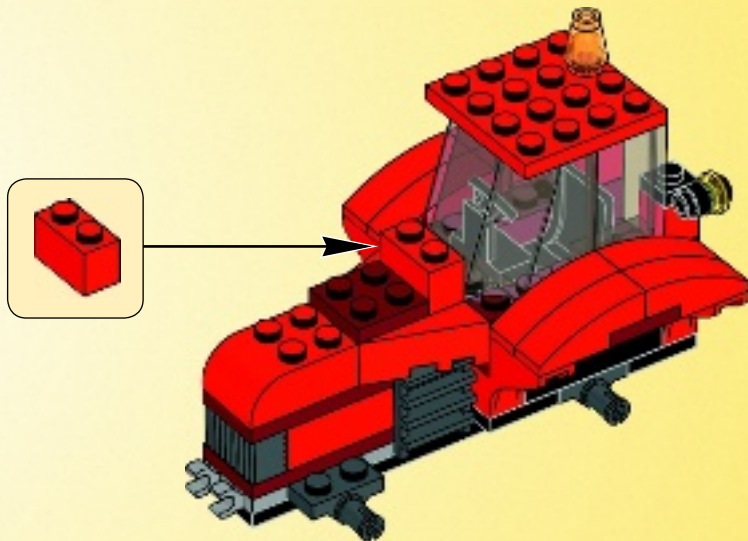



2x



1x



1x

# 21

1



2



3

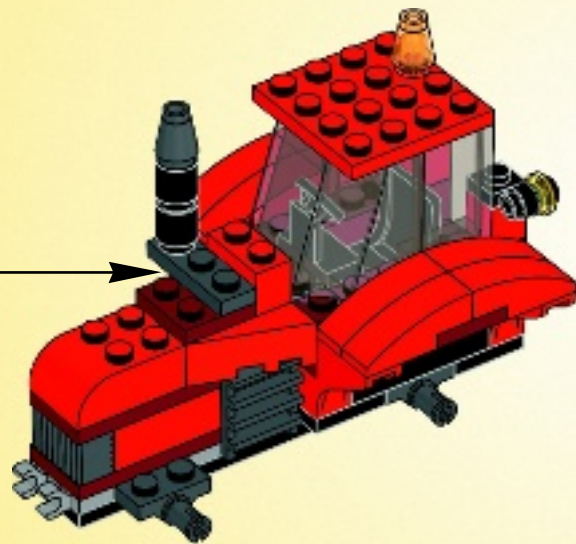



1x

22

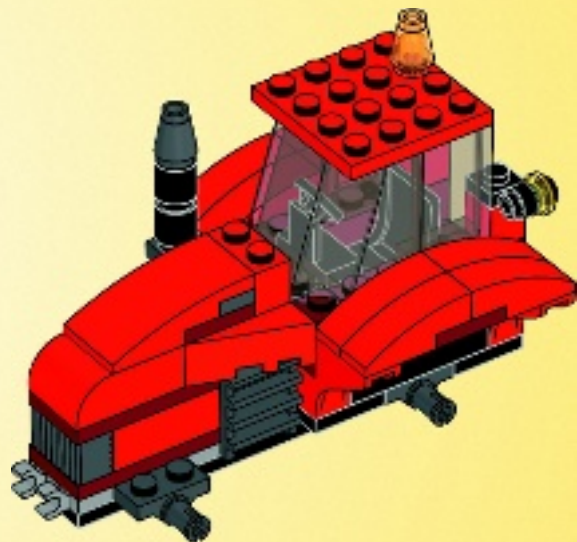



23

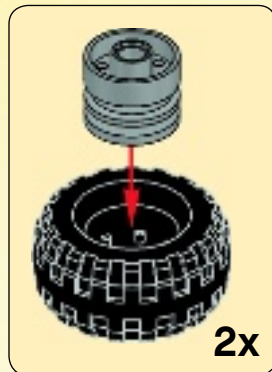
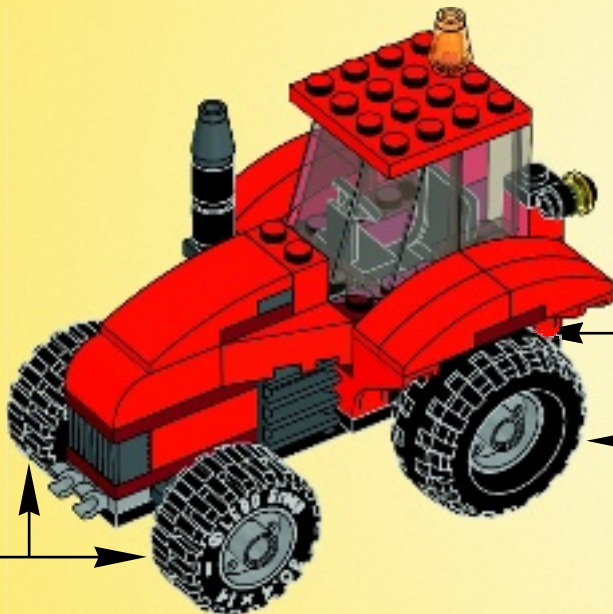
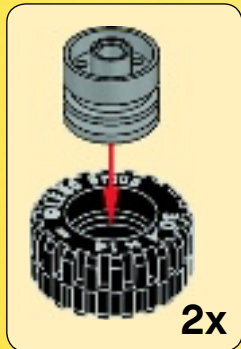



1x

1



1x



1x

2

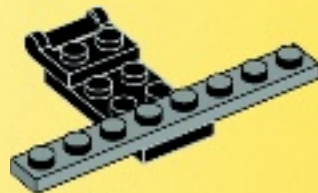



1x

3

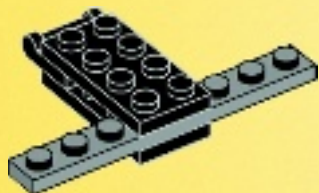

2x

4

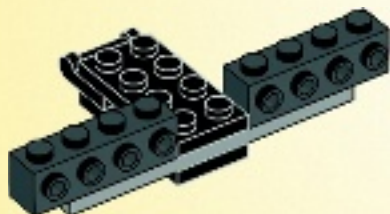



2x

5

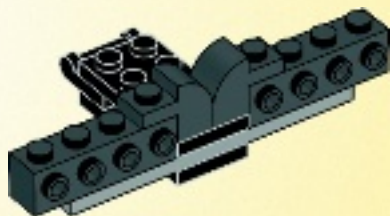

2x

6

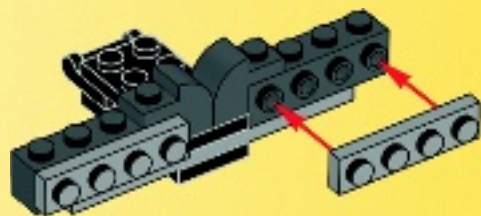

24

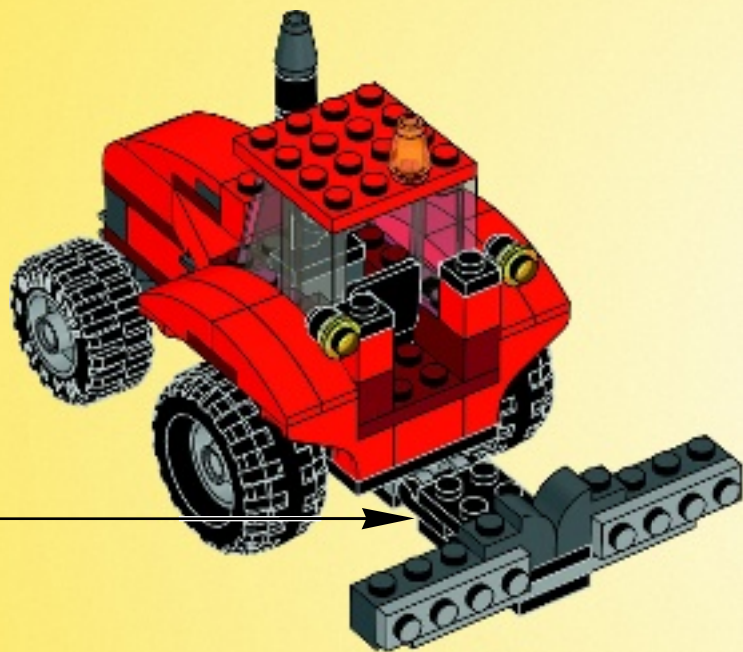
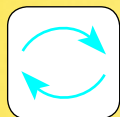





4x

25

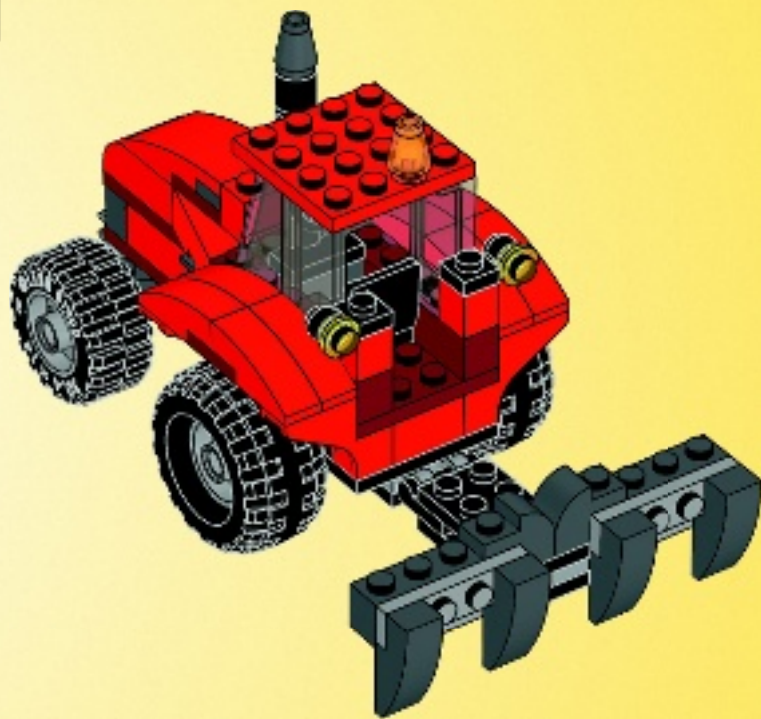



1x

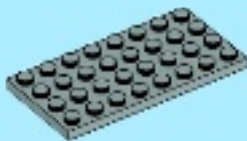

1x

1

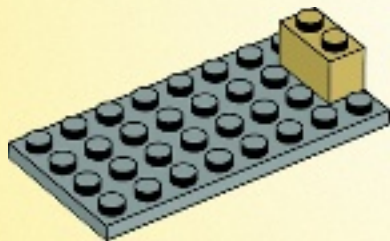



2x



1x

2

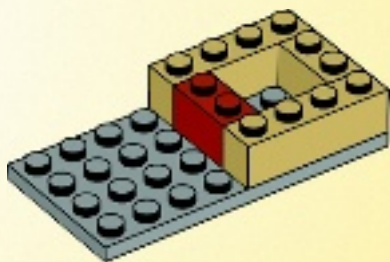

2x



1x

3

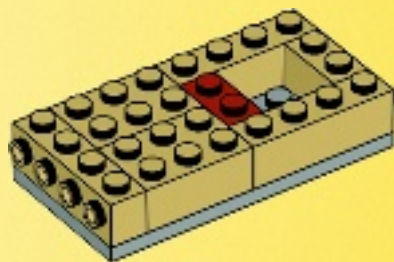



2x



1x

4



2x

5

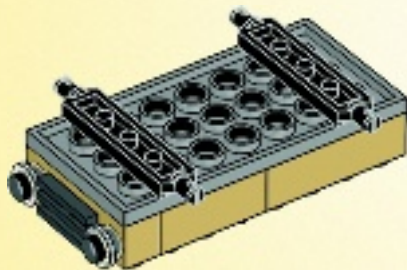
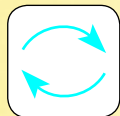



6

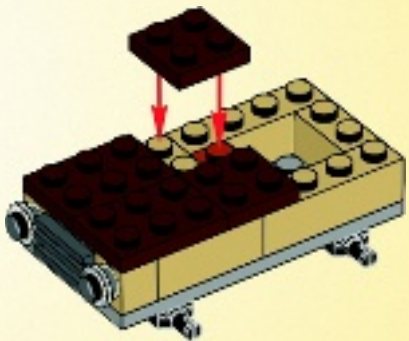
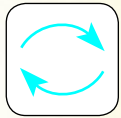

7

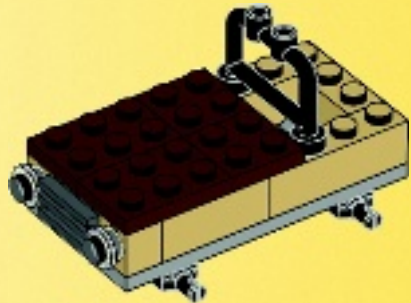



2x



1x

8





1x

9

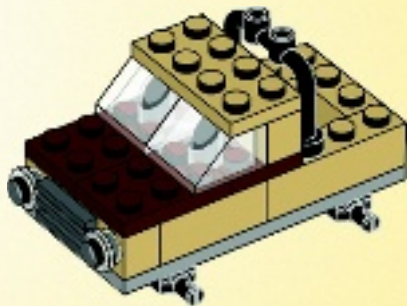

4x



4x

10



4x

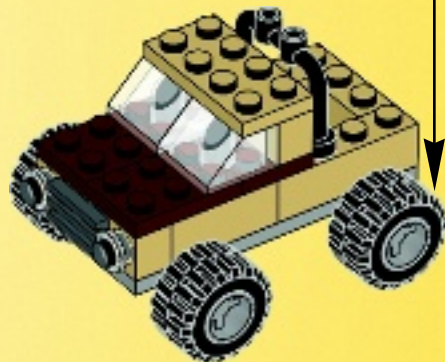



1x

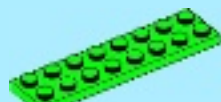

1x

1

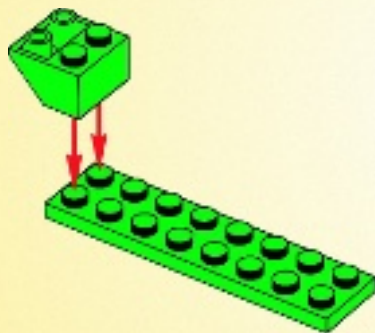



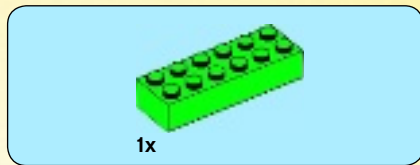

2

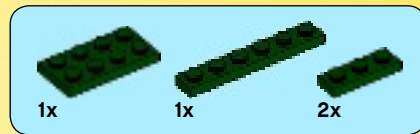
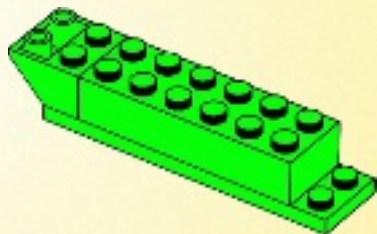

3

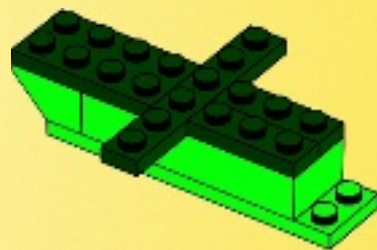

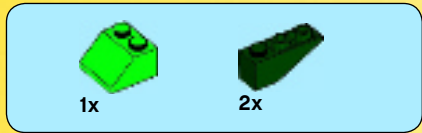

4

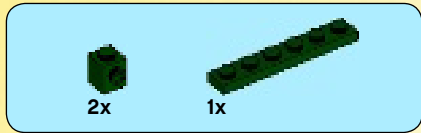
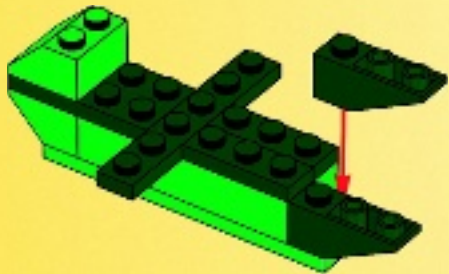

5

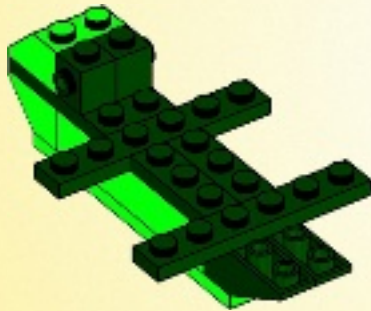



1x

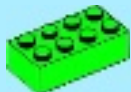

1x

# 6

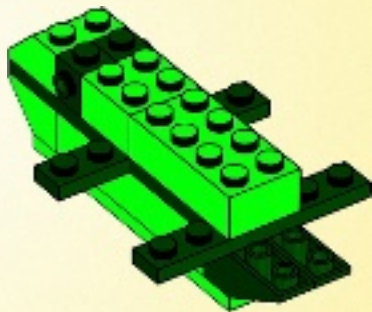

4x

# 7

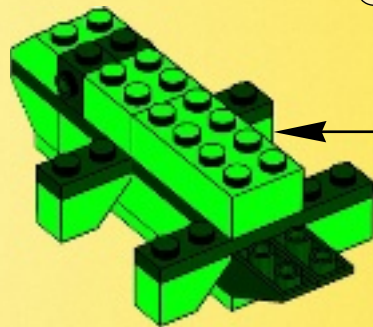

4x



4x

8



4x

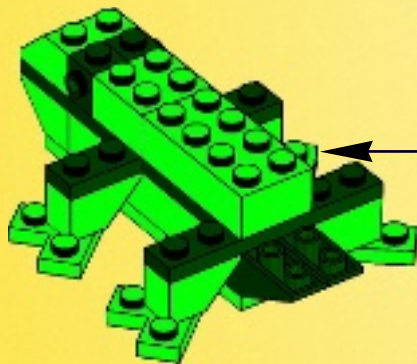

4x



4x

9

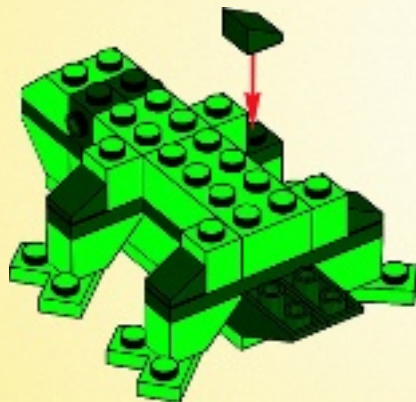

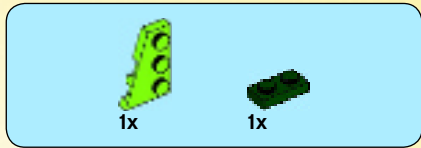

10

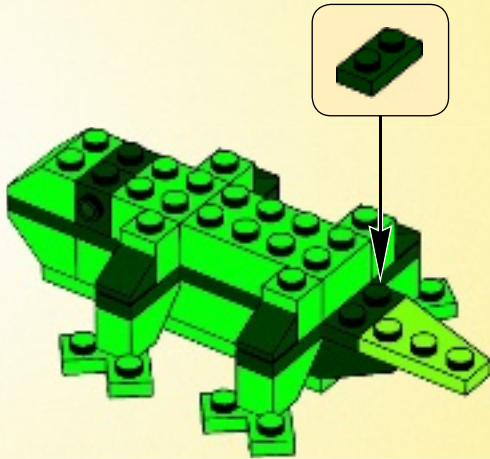

11

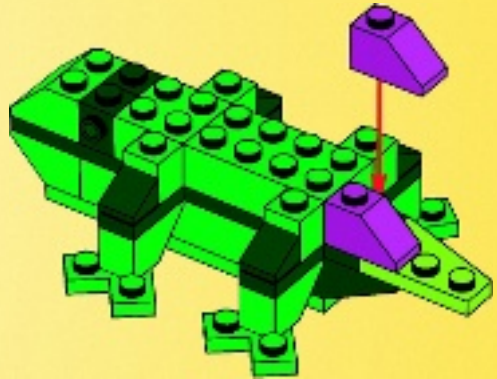



12

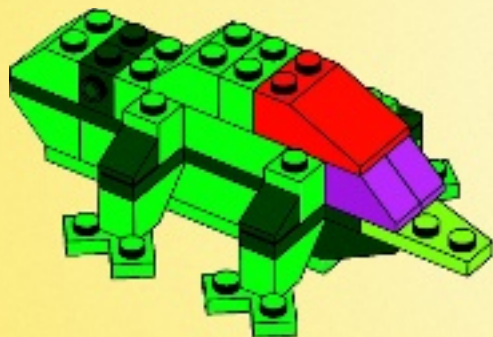



4x

13

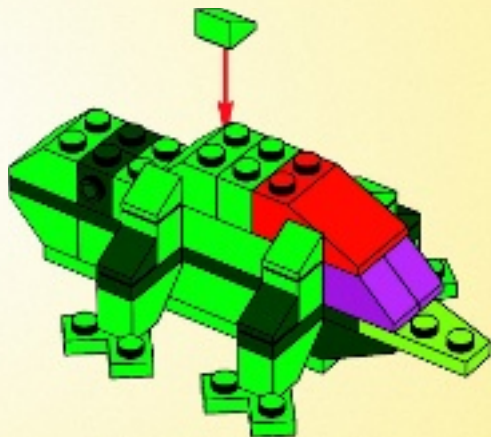

2x

14

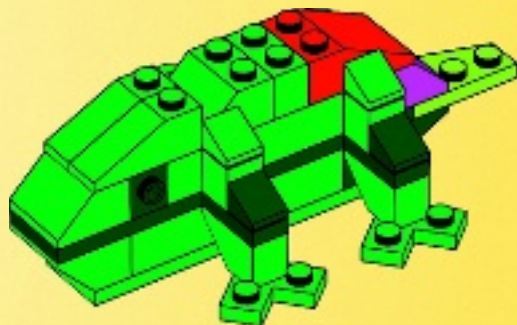



2x



2x

# 15



2x

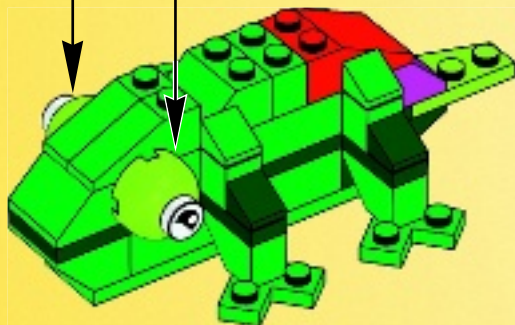

2x



2x



1x

# 16

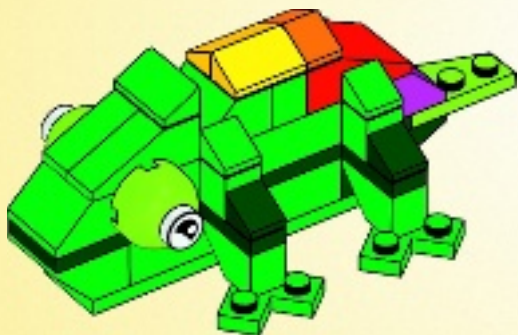



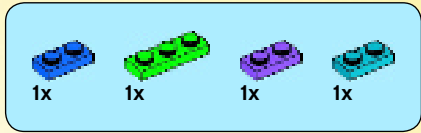

17

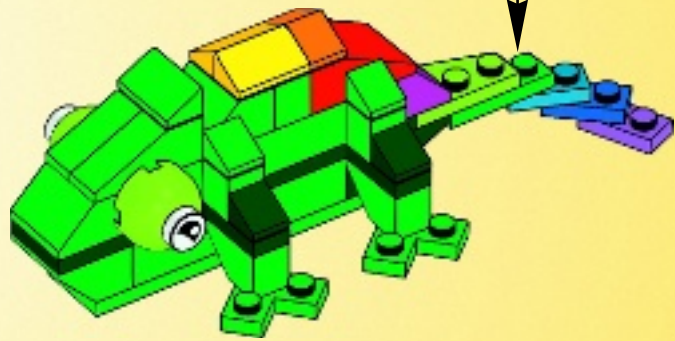
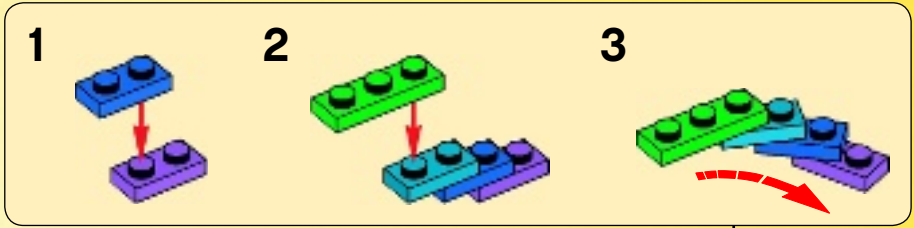



**More ideas online:**  
[LEGO.com/classic](http://LEGO.com/classic)

**Plus d'idées en ligne :**  
**Más ideas en Internet:**  
[LEGO.com/classic](http://LEGO.com/classic)





# CREATOR



31026



31031



31036



3 IN 1

[LEGO.com/creator](http://LEGO.com/creator)

**LEGO CLASSIC**



10696



10692



10701



10699



10693



10694



4x  
300501

8x  
300401

12x  
300301

4x  
300201

8x  
301001

8x  
300101

4x  
300901

2x  
300801

2x  
6099548

2x  
6029156

6x  
462401

2x  
4121932

2x  
6023806

4x  
306801

2x  
371001

2x  
4181142

1x  
303201

2x  
4520842

2x  
4521210

1x  
4521943

3x  
4528140

1x  
4584888

2x  
383901

4x  
4218749

8x  
4109995

8x  
4114306

8x  
4162465

8x  
4159739

4x  
4113916

4x  
4201062

4x  
4113915

4x  
4114084

4x  
4114309

2x  
6116614

2x  
4569547

4x  
4114319

1x  
4181134

1x  
4615599

8x  
300521

12x  
300421

8x  
300321

8x  
300221

4x  
301021

8x  
300121

2x  
300921

2x  
300821



1x  
4617857



4x  
306221



1x  
4526929



1x  
4527765



4x  
428621



4x  
329821



4x  
6056816



8x  
4251162



4x  
621521



2x  
4613174



4x  
4113858



1x  
4243814



3x  
614121



8x  
300323



4x  
362223



4x  
300223



4x  
301023



4x  
300123



4x  
300923



1x  
6037384



8x  
4121936



4x  
303923



4x  
302323



4x  
371023



4x  
4600182



3x  
4243815



2x  
383223



12x  
300523



12x  
300423



1x  
6055328



4x  
300524



8x  
300424



8x  
300324



4x  
362224



8x  
300224



4x  
301024



8x  
300124



1x  
4181143



2x  
300824

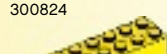

1x  
4639693

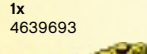

1x  
4218725

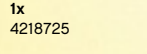

4x  
306224



4x  
4550348



4x  
303924



4x  
243124



3x  
614124



4x  
300526



4x  
300426



8x  
300326



4x  
300226

4x  
292126

4x  
306226

8x  
301026

4x  
300126

2x  
300926

4x  
302026

2x  
379526

2x  
244526

4x  
306926

4x  
4565323

4x  
371026

4x  
4632571

4x  
4185620

1x  
243226

4x  
4225201

4x  
459926

1x  
407926

1x  
408326

6x  
4578677

4x  
4568644

4x  
4619323

2x  
4506553

2x  
292626

1x  
73081

1x  
4144567

2x  
368026

4x  
300528

8x  
4107736

8x  
300328

4x  
4109679

8x  
4109674

4x  
4112838

8x  
4106356

4x  
4111844

1x  
4181135

2x  
4143953

4x  
4546705

3x  
6000071

4x  
4142989

4x  
303928

4x  
4142717

4x  
4107637

5x  
4157120

2x  
4107758

1x  
303428

8x  
4645394

8x  
4579659

4x  
6000743

2x  
6000748



2x  
622740



3x  
3005740



2x  
6024020



2x  
4521504



1x  
4594686



4x  
306541



4x  
306543



4x  
306544



3x  
3005740



4x  
4567333



4x  
6081496



4x  
4173805



8x  
4121739



12x  
4153825



4x  
4118787



8x  
4153826



4x  
4118827



8x  
4153827



2x  
4189007



2x  
4118828



1x  
4654448



2x  
6010736



1x  
4167504



1x  
4543458



4x  
4504371



4x  
4160593



2x  
4650690



4x  
4226179



4x  
4198311



4x  
6096995



4x  
4220634



4x  
4164022



8x  
4220632



4x  
4220631



8x  
4234716



8x  
4165967



4x  
4537919



4x  
4212454



2x  
4279734



4x  
6030276



4x  
4650630



4x  
4537928



4x  
4164021



4x  
4187743



3x  
4183133



1x  
4539907



1x  
4539908



4x  
4519195



4x  
6056373



4x  
6056382



4x  
4625626



8x  
4518889



4x  
6037650



2x  
6022656



3x  
6056292



4x  
6115085



2x  
4654105



4x  
6099347



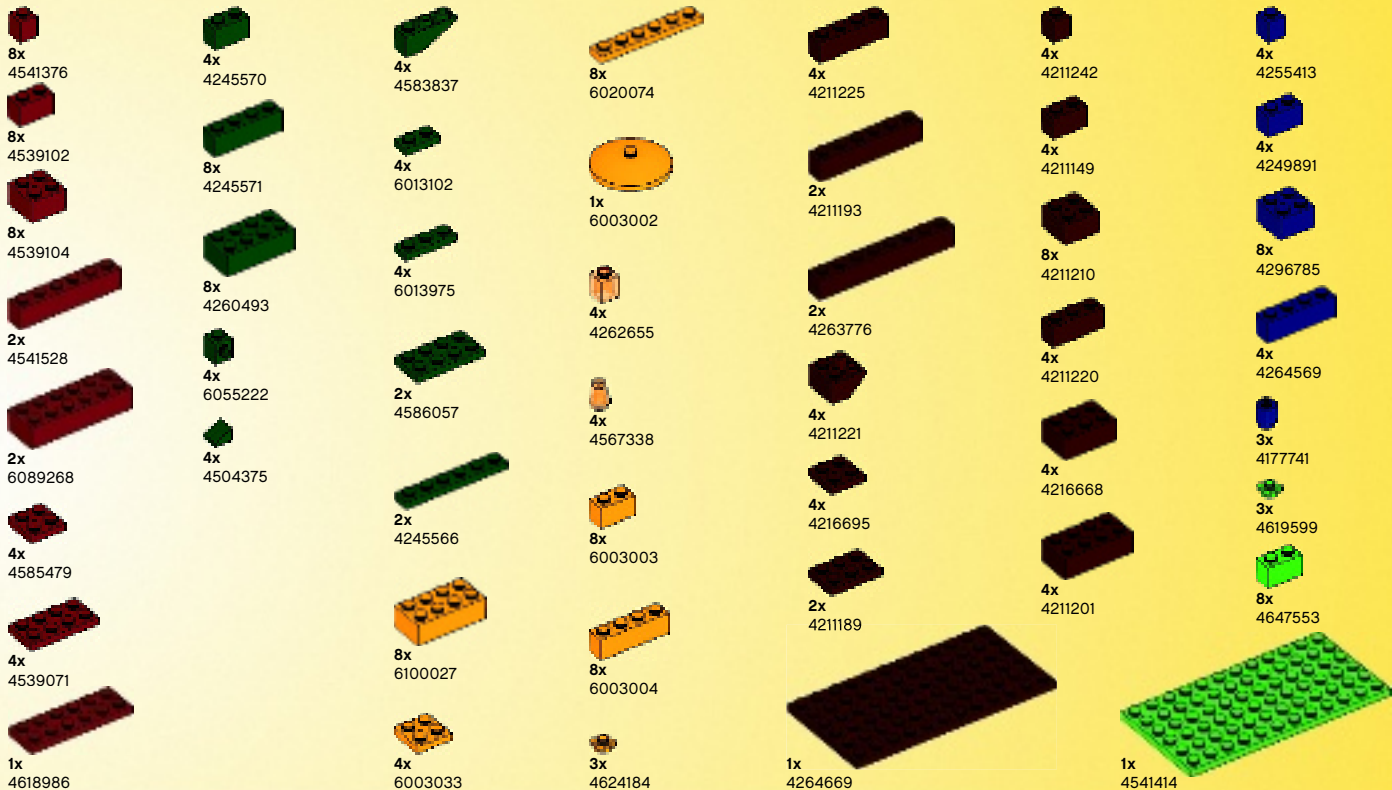

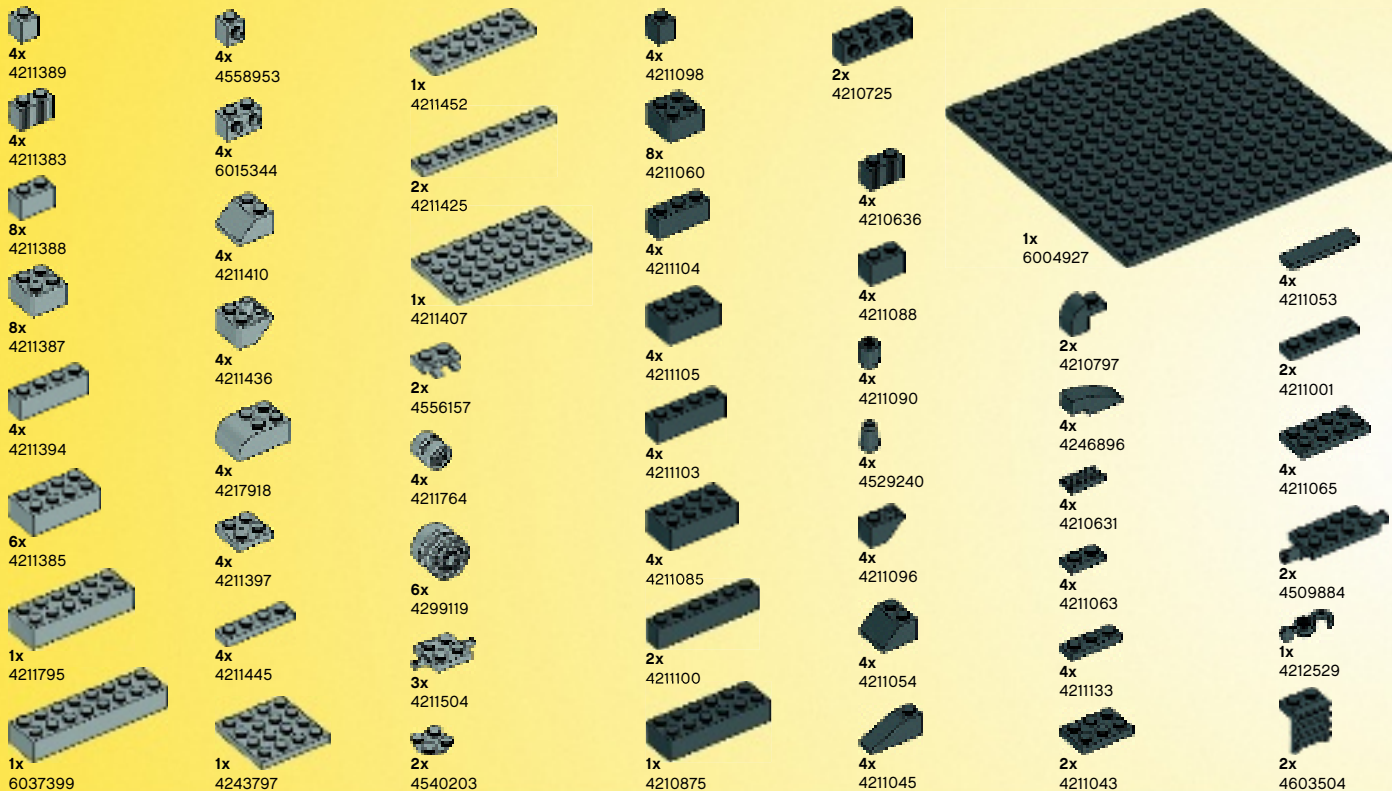

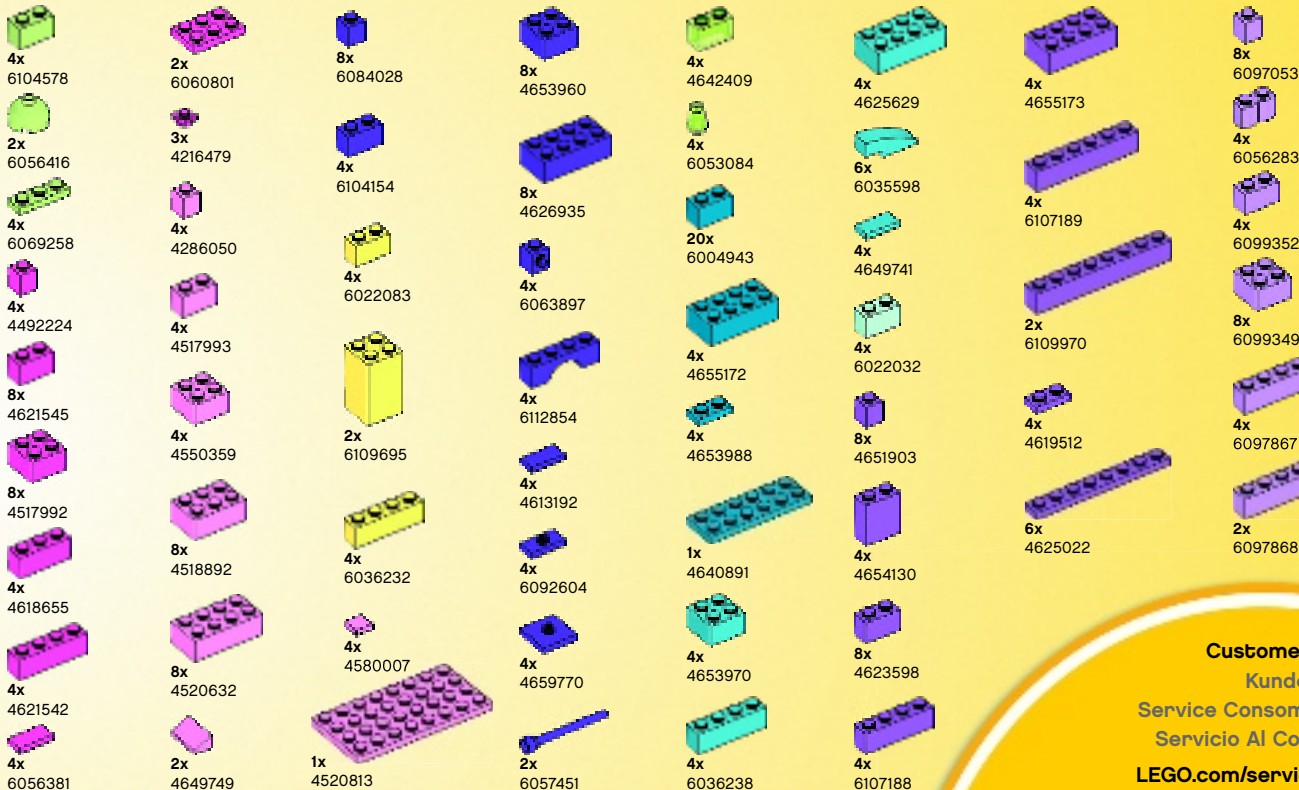

Customer Service

Kundenservice

Service Consommateurs

Servicio Al Consumidor

LEGO.com/service or dial



: 00800 5346 5555

: 1-800-422-5346

# WIN

GO TO [WWW.LEGO.COM/PRODUCTFEEDBACK](http://WWW.LEGO.COM/PRODUCTFEEDBACK) AND  
GIVE US YOUR SHORT **FEEDBACK** ABOUT THIS  
LEGO® SET FOR A CHANCE TO WIN  
A COOL LEGO PRIZE.



## LEGO.com/productfeedback

### GEWINNE



Erzähle uns auf  
[www.LEGO.com/productfeedback](http://www.LEGO.com/productfeedback)

etwas über die Erfahrungen, die du mit  
diesem LEGO® Set gemacht hast, und  
sichere dir die Chance auf einen coolen  
LEGO Preis!

### GAGNE



Rends-toi sur  
[www.LEGO.com/productfeedback](http://www.LEGO.com/productfeedback)

et donne-nous quelques commentaires  
sur ce produit LEGO® pour avoir une  
chance de gagner un prix LEGO !

### GANAN



Visita  
[www.LEGO.com/productfeedback](http://www.LEGO.com/productfeedback)

y envíanos tu opinión acerca de este set  
LEGO®. ¡Participarás en el sorteo de un  
premio LEGO!

### 获取奖品



登录  
[www.LEGO.com/productfeedback](http://www.LEGO.com/productfeedback)

给出关于此乐高®套装的简短反馈，  
就有机会获得炫酷乐高奖品

LEGO and the LEGO logo are trademarks of the/son des marques de commerce du/  
son marcas registradas de LEGO Group. ©2015 The LEGO Group.